

Instructions for Use
SKYRIZI[®] (sky-RIZZ-ee)
(risankizumab-rzaa)
injection, for subcutaneous use

4 x 90 mg/mL single-dose prefilled syringes for a total 360 mg/4 mL dose

Read Before First Use

Refer to the **Medication Guide** for product information.

SKYRIZI Single-Dose Prefilled Syringe

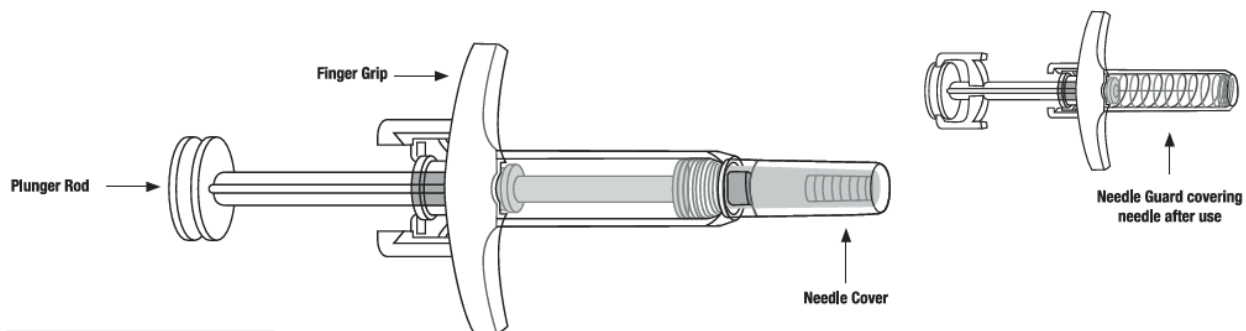

Keep SKYRIZI and all medicines out of the reach of children.

Important Information:

- Keep SKYRIZI in the original carton to protect from light until time to use.
- The liquid should look clear to slightly yellow and may contain tiny white or clear particles.
- **Do not** use SKYRIZI if the liquid is **discolored, cloudy** or contains **flakes** or **large particles**. **Return product** to pharmacy.
- **Do not** use SKYRIZI if the **expiration date (EXP:)** shown on the carton and prefilled syringe has passed. **Return product** to pharmacy.
- **Do not** use SKYRIZI if the liquid has been **frozen** (even if thawed).
- **Do not** shake the syringe.
- **Do not** use SKYRIZI if the prefilled syringe has been **dropped** or **damaged**. **Return product** to pharmacy.
- **Do not** use SKYRIZI if carton perforations are **broken**. **Return product to the pharmacy**.
- **Do not** remove the needle cover until right before giving the injections.
- SKYRIZI is not made with natural rubber latex.

Please Read Complete Instructions for Use Before Using SKYRIZI Prefilled Syringe

Before Injecting:

- **Receive** training on how to inject **SKYRIZI** before giving injections. Call your healthcare provider or **(866) SKYRIZI** or **(866) 759-7494** if you need help.
- **Mark your calendar** ahead of time to remember when to take SKYRIZI.
- **Leave** the carton at room temperature and out of direct sunlight for **15 to 30 minutes** to warm.

- **Do not** remove the prefilled syringes from the carton while allowing SKYRIZI to reach room temperature.
- **Do not** warm SKYRIZI in any other way (for example, **do not** warm it in a microwave or in hot water).

Important Information:

- The liquid should look clear to slightly yellow and may contain tiny white or clear particles.
- **Do not** use SKYRIZI if the liquid is **discolored, cloudy** or contains **flakes** or **large particles**. **Return product** to pharmacy.
- Do not use SKYRIZI if the **expiration date (EXP:)** shown on the carton and prefilled syringe has passed. **Return product** to pharmacy.
- **Do not** use SKYRIZI if the prefilled syringe has been **dropped** or **damaged**. **Return product** to pharmacy.
- **Do not** use SKYRIZI if carton perforations are **broken**. **Return product** to pharmacy.





Storage Information:

- Store SKYRIZI in the refrigerator between **36°F to 46°F** (2°C to 8°C).
- **Do not** shake SKYRIZI.
- Keep SKYRIZI in the original carton to protect from light until time to use.
- SKYRIZI is not made with natural rubber latex.
- **Do not** use if liquid has been frozen (even if thawed).

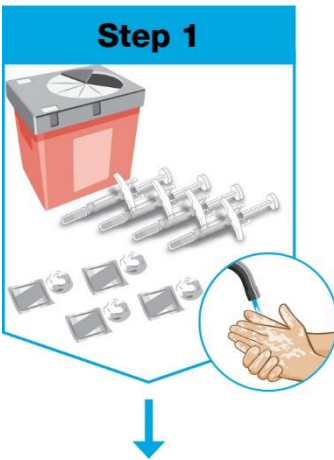
Keep SKYRIZI and all medicines out of the reach of children.

Call your healthcare provider or **(866) SKYRIZI** or **(866) 759-7494** if you need help or do not know how to proceed.



1 Full Dose =  +  +  + 

For a full dose, 4 injections are required, one after the other.

Gather the supplies for the injections and place the following on a clean, flat surface:

- **4 prefilled syringes**
- **4 alcohol swabs** and **4 cotton balls** or gauze pads (not included)
- **FDA-cleared sharps disposal container** (not included)
See “**Used SKYRIZI Prefilled Syringe Disposal**” for information on how to throw away (dispose of) used prefilled syringes.

Wash and dry your hands.

Start with 1 prefilled syringe for first injection.

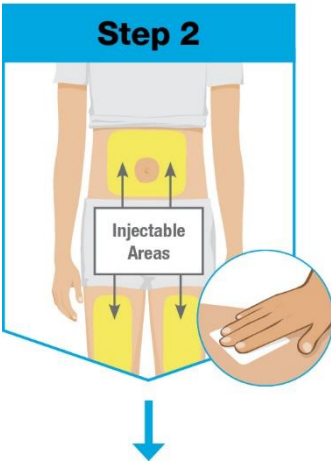

Pick from the 3 injectable areas:

- Front of **left thigh** or **right thigh**
- Your **abdomen** (belly) at least 2 inches from your navel (belly button)

When using the 2nd, 3rd, and 4th syringes:



Pick injection sites **at least 1 inch away** from each other. **Do not inject into the same site.**

Wipe the injection site in a circular motion with the alcohol swab (before **all four injections**)

- **Do not** touch or blow on the injection site after it is cleaned. Allow the skin to dry before injecting.
- **Do not** inject through clothes.
- **Do not** inject into skin that is sore, bruised, red, hard, scarred, or has stretch marks.

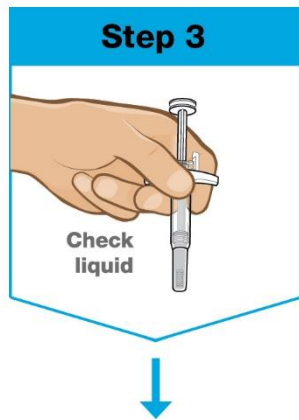

Hold the prefilled syringe with covered needle facing down, as shown.

Check the liquid in the prefilled syringe.

- It is normal to see one or more bubbles in the window.
- The liquid should look clear to slightly yellow and may contain tiny white or clear particles.
- **Do not** use the prefilled syringe if liquid is **discolored**, **cloudy** or contains **flakes** or **large particles**.

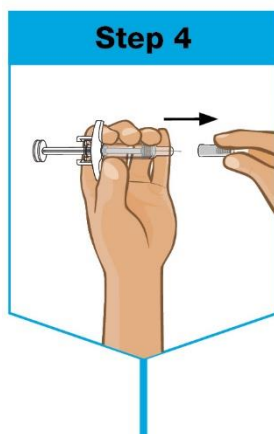

Remove the needle cover.

- **Do not** hold or pull plunger rod when removing the needle cover.
- Hold the syringe in 1 hand between the finger grip and needle cover.
- With the other hand, carefully pull the needle cover straight off.
- You may see a drop of liquid at the end of the needle. This is normal.
- Throw away the needle cover.
- **Do not** touch the needle with your fingers or let the needle touch anything.

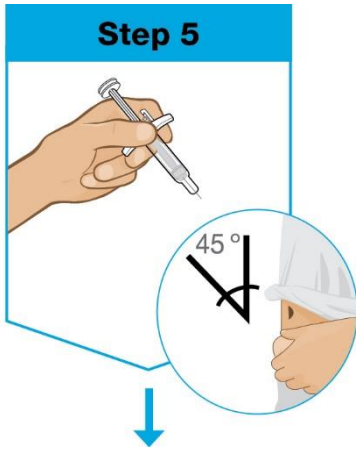

Hold the body of the prefilled syringe in 1 hand between the thumb and index finger.

Gently pinch the area of cleaned skin with your other hand and hold it firmly.

Insert the needle into the skin at about a **45-degree angle** using a quick, short movement. Hold angle steady.

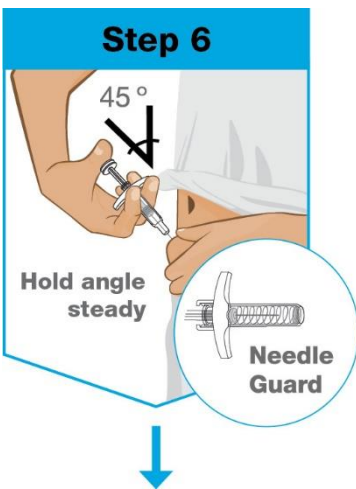

Slowly push the plunger rod all the way in until all of the liquid is injected and the syringe is empty.

Pull the needle out of the skin while keeping the syringe at the same angle.

Release the plunger rod.

- Allow the prefilled syringe to move up until the entire needle is covered by the needle guard.

The needle guard will not automatically activate unless all the liquid has been injected.

- Press** a cotton ball or gauze pad over the injection site and hold for 10 seconds.
- Do not** rub the injection site. You may have slight bleeding. This is normal.



Repeat Steps 2 through 6 with the 2nd, 3rd, and 4th prefilled syringe for a **full dose**.

- Use the 2nd, 3rd, and 4th prefilled syringe right after using the 1st syringe.

When using the 2nd, 3rd, and 4th syringes:



Pick injection sites **at least 1 inch away** from each other. **Do not inject into the same site.**



Put your used prefilled syringes in an **FDA-cleared sharps disposal container right away after use.**

- Do not throw away (dispose of) used prefilled syringes in the household trash.

For more information, or if you do not have an FDA-cleared sharps container see “**Used SKYRIZI Prefilled Syringe Disposal**” section located on the other side of these instructions.

Questions About Using the SKYRIZI Syringe

Q. What if I have not received in-person training from a healthcare professional?

A. Call your healthcare provider or **(866) SKYRIZI** or **(866) 759-7494** if you need help. **Receive** training on how to inject **SKYRIZI** before giving injections.

Q. What should I do with all four used prefilled syringes after my injections?

A. Throw away (dispose of) all 4 used prefilled syringes in a sharps disposal container. **Do not** put in household trash. For more information, see “**Used SKYRIZI Prefilled Syringe Disposal**” section.

You can sign up to receive sharps containers for SKYRIZI prefilled syringe disposal at no additional cost by going to www.SKYRIZI.com or calling (866) 759-7494

Q. How do I know when the injection is complete?

A. The injection is complete when the prefilled syringe is empty, the plunger rod is pushed all the way in, and the syringe needle guard is activated.

Used SKYRIZI Prefilled Syringe Disposal

Throw away (dispose of) all four used prefilled syringes in a sharps disposal container. **Do not** put in household trash.

If you do not have an FDA-cleared sharps disposal container, you may use a household container that:

- is made of a heavy-duty plastic,
- can be closed with a tight-fitting, puncture-resistant lid, without sharps being able to come out,
- stays upright and stable during use,
- is leak-resistant, and
- has been properly labeled to warn of hazardous waste inside the container.

When your sharps disposal container is almost full, you will need to follow your community guidelines for the right way to dispose of your sharps disposal container. There may be state or local laws about how you should throw away used needles and syringes.

For more information about safe sharps disposal, and for specific information about sharps disposal in the state that you live in, go to the FDA's website at: www.fda.gov/safesharpsdisposal.

Do not recycle your used sharps disposal container.

Manufactured by: AbbVie Inc., North Chicago, IL 60064, U.S.A.

US License Number 1889

SKYRIZI® is a trademark of AbbVie Biotechnology Ltd.

© 2019-2024 AbbVie Inc.

20078144

This Instructions for Use have been approved by the U.S. Food and Drug Administration.

Revised: 3/2024